

SERIES:

MGDN6



3003 9th Avenue SW  
 PO Box 50  
 Watertown, SD 57201  
 Toll free: 888-978-2638  
 Ph: 605-886-3326  
 Fax: 605-886-8995



Low Profile, High Current Power Inductors

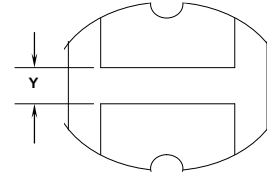
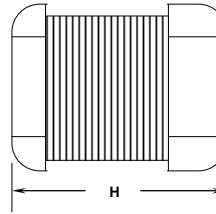
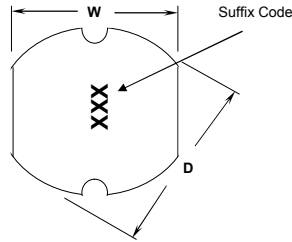
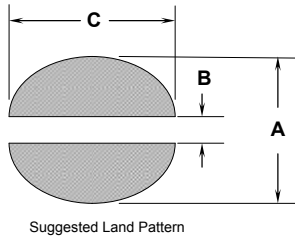

Series Number	Maximum Dimensions			Reference Dimensions				
	Units	L	W	H	Y	A	B	C
MGDN6	inches	0.409"	0.370"	0.228"	0.114"	0.433"	0.114"	0.370"
	[ mm ]	[ 10.40 ]	[ 9.40 ]	[ 5.80 ]	[ 2.90 ]	[ 11.00 ]	[ 2.90 ]	[ 9.40 ]

Features:

- High energy storage and low resistance
- Reliable surface mounting, flat top for pick and place.
- Smaller real estate than other common inductors.
- Robust temperature deflection to prevent damage during solder reflow.
- Tape and Reel mechanical specifications available upon request.
- Operating Temperature -40°C to +85°C.
- Highly resistive core for EMI suppression applications.

Notes:

- Inductance measured at 100kHz and 250mVrms.
- Isat is a maximum applied AC + DC current.
- Isat current is applied to produce a typical 35% drop in nominal inductance.
- Tolerance suffix of M = ±20%.
- DCR is a maximum at 20°C.

260°C Maximum reflow temperature per J-STD020  
 Terminal Plating is Hot Dipped SnAgCu



Schematic Diagram

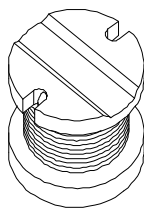
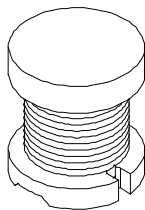
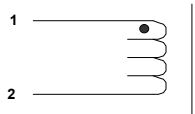

Contact CoEv for additional inductance values

MGDN6				
Lead Free Part Number	L μH	DCR	IsAT	Tolerance
		W	A	Suffix
	1.0			
	1.4			
	1.8			
	2.2			
	2.7			
	3.3			
	3.9			
	4.7			
	5.6			
	6.8			
	8.2			
MGDN6-00002	10	0.06	2.60	M
MGDN6-00003	12	0.07	2.45	M
MGDN6-00004	15	0.08	2.27	M
MGDN6-00005	18	0.09	2.15	M
MGDN6-00006	22	0.10	1.95	M
MGDN6-00007	27	0.11	1.76	M
MGDN6-00008	33	0.12	1.50	M
MGDN6-00009	39	0.14	1.37	M
MGDN6-00010	47	0.17	1.28	K
MGDN6-00011	56	0.19	1.17	K
MGDN6-00012	68	0.22	1.11	K
MGDN6-00013	82	0.25	1.00	K
MGDN6-00014	100	0.35	0.97	K
MGDN6-00015	120	0.40	0.89	K
MGDN6-00016	150	0.47	0.78	K
MGDN6-00017	180	0.63	0.72	K
MGDN6-00018	220	0.73	0.66	K
MGDN6-00019	270	0.97	0.57	K
MGDN6-00020	330	1.15	0.52	K
MGDN6-00021	390	1.30	0.48	K
MGDN6-00022	470	1.48	0.42	K
MGDN6-00023	560	1.90	0.33	K
MGDN6-00024	680	2.25	0.28	K
MGDN6-00025	820	2.55	0.24	K
	1000			

Specifications subject to change

Call Toll Free: 888-978-2638 Website: [www.tycopowercomponents.com](http://www.tycopowercomponents.com)

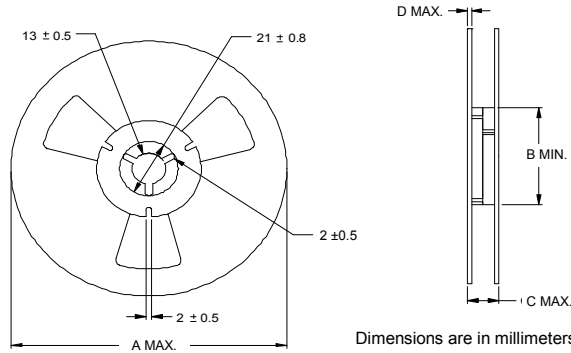

Series Number	Reel dimensions				Reel Qty	Carton (Box) Qty.	Packaging Specification	
	Units	A	B	C				D
MGDN6	in.	12.99"	4.02"	1.19"	0.106"	800	4000	90-0052
	[mm]	[330]	[102.0]	[30.2]	[2.70]			

PACKAGING NOTE: Only pressure sensitive cover tape is to be used.

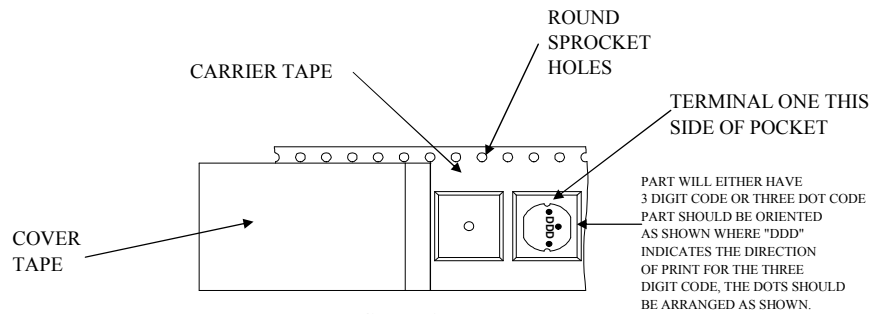
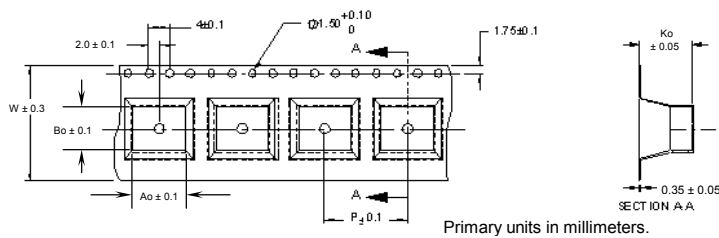

FIGURE 1  
CARRIER TAPE AND PART



Series	Ao	Bo	W	P	Ko
MGDN6	9.50	10.50	24.0	12.0	5.90



RoHS Compliant

**Customer Packaging Specifications**  
For Print Distribution to Customers

Series  
**MGDN6**

Revision  
**A0**

Sheet 2 of 3

Item	Specification	Test Method/Condition
<b>Environmental</b>		
Static Humidity	After exposure part remains within specified electrical parameters for L, Q and DCR.	Expose parts to an environment of +50°C with 90 to 95% R.H. for 100 hours. After exposure, allow parts to dry for 2 hours before measurements are taken.
Storage Life	After exposure part remains within specified electrical parameters for L, Q and DCR.	Subject parts to an environment of +50°C 90 to 100% R.H. for 46 to 50 hours. After exposure, allow parts to dry for 2 hours before measurements are taken.
Moisture Resistance	After exposure, part shall not have a shorted or open winding.	Per MIL-STD 202 Method 106, ten 24 hour cycles at +25°C to +65°C at 80 to 95% R.H. During any of the first 9 cycles, inductors are revolved from the chamber and exposed to -10°C for 3 hours. Allow parts to dry for 2 hours before measurements are taken.
Temperature Cycle	After exposure part remains within specified electrical parameters for L, Q and DCR.	10 cycles (Air to Air) 1 cycle shall consist of: 30 minutes exposure to +85°C 30 minutes exposure to -40°C Allow 20 minutes transition between extremes.
Temperature Shock	After exposure part remains within specified electrical parameters for L, Q and DCR.	10 cycles (Air to Air) 1 cycle shall consist of: 30 minutes exposure to -45°C 30 minutes exposure to +125°C 15 seconds maximum transition between temperatures
<b>General</b>		
Storage Temperature Range	-40°C to +85°C	
Operating Temperature Range	-40°C to +85°C	
Flammability	IEC 695-2-2	Withstands needle-flame test
<b>Other</b>		
Vibration	After exposure part remains within specified electrical parameters for L, Q and DCR.	Inductors shall be randomly vibrated per NAVMAT P9492 profile. Samples shall be subjected to 0.04G/Hz for a minimum of 15 minutes per axis, for each of the three axes.
Mechanical Shock	After exposure part remains within specified electrical parameters for L, Q and DCR.	Test per MIL-STD 202 method 213 test condition A, test mounted samples 3 axes, 6 times, totaling 18 shocks. (50Gs, 11ms, half-sine).
Solderability	Wetting shall cover 90% minimum of each termination	Dip pads in RMA flux, 63/37 solder (Sn/Pb) at 232°C for 5 seconds ±2 seconds.
Component Adhesion (Push Test)	4 pounds	Apply and measure force with a digital force gauge set.
Resistance to Solvent	No sign of degradation in appearance or marking detail.	Withstands 6 minutes of alcohol. Withstands 3 minutes forced spray Freon TMS
Load Life	After exposure, part shall not have a shorted or open winding.	Parts to be stored at 110°C for 1000 hours with rated current applied. Parts to be tested at: start, 500 and 1000 hours. Allow 2 hours at room temperature before testing.



<b>For Print Distribution to Customers</b>	<b>Series</b>	<b>Revision</b>
	<b>MGDN6</b>	<b>A0</b>
	<b>Sheet 3 of 3</b>	